

SilverTape™ AM9304

DIRECT FOAM

Product Information 12.2020

1/2

SilverTape™ AM9304

This product is a double sided high performance acrylic based adhesive tape, which is especially designed for a variety of materials in the present day automotive manufacturing with high surface energy like glass, aluminum and steel. This tape is capable of absorbing the different thermal expansions of two materials. Because of their high density, this tape offers, when used on the right high surface energy substrates, the strongest available bond. This acrylic foam tape has a very high temperature resistance. In combination with a primer this SilverTape family guarantees excellent adhesion performance even on vehicle attachment parts with a medium and low surface energy.

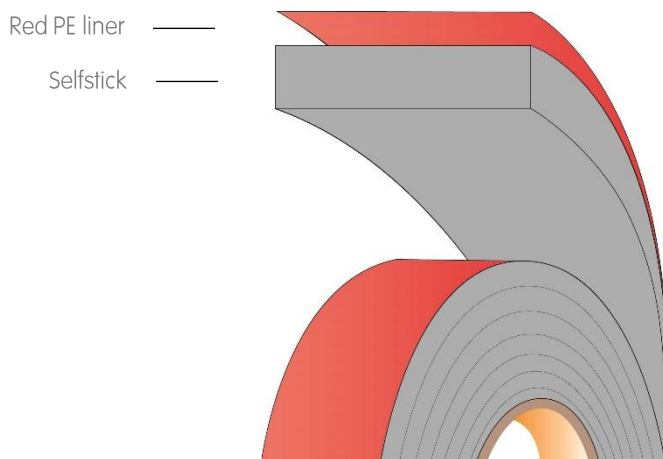

Thickness:	0,4 mm (0.016 inch) ±15%
Core:	Closed cell acrylic
Adhesive:	Closed cell acrylic
Density:	840 kg/m³ (52lb/ft³)
Color:	Gray
Liner:	Red PE liner or Siliconised Paper liner
Temperature Resistance:	
Minimum	-40°C (-40°F)
Short term	190°C (374°F)
Long term	120°C (248°F)

90° Peel Adhesion	N/10mm (lb/in)	28 (16)	ASTM D3330
Dynamic Shear Strength	kPa (lb/in²)	680 (99)	ASTM D-1002
Normal Tensile	kPa (lb/in²)	730 (106)	ASTM D-897
Static Shear Strength	g/312mm² > 10,000 min. (7 days)	22°C (72°F) 1000 66°C (150°F) 500 93°C (200°F) 500 121°C (250°F) 177°C (350°F)	ASTM 3654

Suitable for:

- Glass, glass/epoxy, stainless steel, galvanized steel, anodized aluminum, coated aluminum*

Available sizes:

- jumbo: 900mm x 330 m (76,2mm core)
- log: 900mm x 33/66 m (76,2mm core)
- slit roll: 4 – 250mm x 33/66 m (76,2mm core)
- spool roll: 5 – 25mm x max 600 m (152,4mm core)



The best ideas are **the ones that stick**

SilverTape™ AM9304

DIRECT FOAM

Product Information 12.2020

2/2

Surface	Tape bonding is one of the most variable and easy technology mating substrates. Especially for assemblies made of different substrates having different thermal expansion rates bonding is a easy method for a long term durable joint. AFTC® tape allow a high variation in such substrates as all are available in different thickness. To ensure proper performance of such bonded part follow the following recommendations.
Design	A proper tape bond design means avoiding cleavage and peel forces. Design leading to pure shear and tensile loads have to be preferred to utilize full AFTC® SilverTape™ performance.
Surface Preparation	All bonding process require proper surface preparation / cleaning. This will enable AFTC® SilverTapes™ to get in direct contact with the surface creating full adhesion force. AFTC® SilverClean Dirt & Dust will remove most (polar) contaminations such as fingerprints and light oil. AFTC® SilverClean Oil & Grease is used for more non-polar contaminations as grease or mould release agents. Check suitable cleaner with surface test inks. Use lint free tissues for such operations.
Surface Modification	If simple cleaning cannot achieve appropriate adhesion forces the following surface modifications can be used. For larger scale process operations the use of e.g. flame activation can be used. On smaller scale / repair operations the use of AFTC® SilverPrime or AFTC® SilverActivate might be a solution. AFTC® SilverPrime 101(UV) is used for plastics or similar coatings which have a low surface energy (PE, PP). For glass AFTC® SilverPrime 201 is used when exposed to humid environments. AFTC® SilverActivate 301 is a "one step clean and prime" solution used for a variety of car paints. All primer / activators should only be used on the area for bonding. Excess material has to be cleaned immediately. For mill finished aluminium or stainless steel mild abrasion using AFTC® SilverPads followed by cleaning using AFTC® SilverClean Dirt & Dust is an option.
Temperature	After proper surface preparation / modification AFTC® SilverTapes™ should be applied at a temperature level above 18°C (65°F). For temperatures below this but above 0°C (32°F) use AFTC® low temperature SilverTapes™.
Pressure	Ensure immediate part assembly after liner removal. Pressure should be applied in rolling fashion at approx. 10N/cm². Recommended roller speed at 10 mm/s (24 in./min.). Higher velocities might require higher pressure or control with surface pressure films. AFTC® SilverTapes™ achieve their full strength after 24h at ambient temperature. Higher temperatures can accelerate strength development.
Storage & Shelf Life	Store AFTC® SilverTapes™ between 5° and 35°C (40°-95°F). Humid condition causing condensation should be avoided. For products with non-siliconized liners shelf life is 24 months; products with siliconized liners and AFTC splice-/tabbing tapes shelf life is at 12 months.
Disclaimer	All technical data in this product data sheet are based on AFTC's experience and external testing institutes. These values are representative for the overall performance. These data sheets are NOT to be used for specification purposes or for your own specific application. It is your responsibility to test whether the tape is suitable for your application or project. AFTC® will NOT be held liable for any information provided on this data sheet. Please follow the rules and regulations that are applicable in the state, county or country where the AFTC product(s) are being used. If you have any questions regarding the use of the AFTC® SilverTape™ acrylic foam tapes, please contact your local sales team. For questions on the standard warranty, please review our terms and conditions. For all other warranties, please review all documents that should have been agreed to in writing prior to the sale between AFTC® and the customer. SilverTape™ is a brand name of AFTC®.

The best ideas are **the ones that stick**